



rubicer

SPC

					Rigid
		Brown 09	Black 09	Grey 09	
				XL1.8	
Home 11	Country 13	City 15	Beach 17		
				Essentials	
Oak 19	Marron 21	Avelana 23	Ceniza 25		
				Impress	
	Icarus 27	Acacia 29	Roble 30		
				Wood	
		Pinho 31	Plus 33		
				Herringbone	
		Light 35	Dark 35		
				Premium	
Cream 36	Moka 37	Milk 38	Cappuccino 39		
					Habitat
Olmo 41	Amendoa 42	Gold Vanilla 43	Graphite 44	Violino 45	
				Pro	
Nordig 46	Brown 47	Grey 48	Caramel 49		
				Loft	
	Ivory 50	Ash 51	Honey 53		
				Wall Pro	
	Silver 58	Griggio 58	Dark Grey 58		





Qt. / box
5 Pcs
1,80 m²
19,75 Kg



Qt. / Pal
42 box
75,60 m²
850 Kg

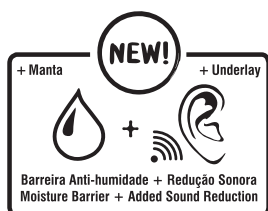

60x60 - 6,5/0,7mm SPC

Já inclui Tela na base

SP40/56

Série: **Rigid Grey - EIR**

Ref.: RSPC6060GR



5 606779 252692

Underlay Included

Inclus la sous couche incorporer



Rodapé Alumínio
8cm - 2,50m

Ref.: RAO00R80NMT

Cód.: **SP22/31 Unit**

60x60 - 6,5/0,7mm SPC

Já inclui Tela na base

SP40/56

Série: **Rigid Black - EIR**

Ref.: RSPC6060BLK



5 606779 252708

Underlay Included

Inclus la sous couche incorporer



Rodapé Alumínio
6cm - 2,70m

Ref.: RLVT3722011

Cód.: **SP15/21 Unit**

60x60 - 6,5/0,7mm SPC

Já inclui Tela na base

SP40/56

Série: **Rigid Brown - EIR**

Ref.: RSPC6060BRW



5 606779 252715

Underlay Included

Inclus la sous couche incorporer



Rigid

VEJA O VÍDEO DE INSTALAÇÃO
CHECK THE INSTRUCTIONS VIDEO
REGARDEZ LA VIDEO D'INSTRUCTION
VEA EL VIDEO DE INSTRUCCIONES







High Traffic
&
Residential
0,55mm



Qt. / box
4 Pcs
1,6723 m²
27,43 Kg



Qt. / Pal
64 box
107,03 m²
1.755 Kg



Rodapé Compatível
7cm - 2,20m

Ref.: RRDPWD1002

Cód.: **SP13/18.2 Unit**

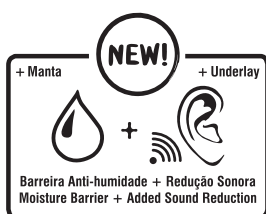

XL1.8 Home



23x182 - 8/0,55mm SPC
Já inclui a Tela/Manta colada na base

Série: **XL1.8 Home - EIR**

Ref.: RSPC23183XLHO

SP45/63



5 606779 267078

Underlay Included
Inclus la sous couche incorporer

VEJA O VÍDEO DE INSTALAÇÃO
CHECK THE INSTRUCTIONS VIDEO
REGARDEZ LA VIDEO D'INSTRUCTION
VEA EL VIDEO DE INSTRUCCIONES







High Traffic
&
Residential
0,55mm



XL1.8 Country



Qt. / box
4 Pcs
1,6723 m²
24 Kg



Qt. / Pal
64 box
107,03 m²
1.536 Kg



Rodapé Compatível
7cm - 2,20m

Ref.: RRDPWD1010

Cód.: **SP13/18.2 Unit**



Rodapé Branco
7cm - 2,20m

Ref.: RRDPTH003

Cód.: **SP12/16.8 Unit**

23x182 - 7/0,55mm SPC
Já inclui a Tela/Manta colada na base

SP45/63

Série: **XL1.8 Country - EIR**

Ref.: RSPC23183XLCO



5 606779 255600

Underlay Included
Inclus la sous couche incorporer

VEJA O VÍDEO DE INSTALAÇÃO
CHECK THE INSTRUCTIONS VIDEO
REGARDEZ LA VIDEO D'INSTRUCTION
VEA EL VIDEO DE INSTRUCCIONES







High Traffic
&
Residential
0,55mm



Qt. / box
4 Pcs
1,6723 m²
24 Kg

Qt. / Pal
64 box
107,03 m²
1.536 Kg



Rodapé Branco
7cm - 2,20m

Ref.: RRDPTH003

Cód.: **SP12/16.8 Unit**



XL1.8 City



23x182 - 7/0,55mm SPC
Já inclui a Tela/Manta colada na base

Série: **XL1.8 City - EIR**

Ref.: RSPC23183XLCIT

SP45/63



5 606779 255617

Underlay Included
Inclus la sous couche incorporer

VEJA O VÍDEO DE INSTALAÇÃO
CHECK THE INSTRUCTIONS VIDEO
REGARDEZ LA VIDEO D'INSTRUCTION
VEA EL VIDEO DE INSTRUCCIONES







High Traffic
&
Residential
0,55mm



Qt. / box

4 Pcs
1,6723 m²
24 Kg

Qt. / Pal

64 box
107,03 m²
1.536 Kg



Rodapé Compatível
7cm - 2,20m

Ref.: RRDPTH003

Cód.: SP12/16.8 Unit



XL1.8 Beach



23x182 - 7/0,55mm SPC
Já inclui a Tela/Manta colada na base

Série: **XL1.8 Beach - EIR**

Ref.: RSPC23183XLBE

SP45/63



5 606779 255624

Underlay Included
Inclus la sous couche incorporer

VEJA O VÍDEO DE INSTALAÇÃO
CHECK THE INSTRUCTIONS VIDEO
REGARDEZ LA VIDEO D'INSTRUCTION
VEA EL VIDEO DE INSTRUCCIONES







High Traffic
&
Residential
0,55mm



Qt. / box
7 Pcs
1,931 m²
20,80 Kg



Qt. / Pal
85 box
164,135 m²
1.783 Kg



Rodapé Compatível
7cm - 2,20m

Ref.: RRDPWD1003

Cód.: **SP13/18.2 Unit**

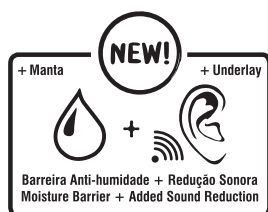

Essentials Oak



18x152 - 6/0,55mm SPC
Já inclui a Tela/Manta colada na base

Série: **Essentials Oak - EIR**

Ref.: RSPCESS18152OAK

SP35/49



5 606779 25365 1

Underlay Included
Inclus la sous couche incorporer

VEJA O VÍDEO DE INSTALAÇÃO
CHECK THE INSTRUCTIONS VIDEO
REGARDEZ LA VIDEO D'INSTRUCTION
VEA EL VIDEO DE INSTRUCCIONES







High Traffic
&
Residential
0,55mm



Essentials Marron



Qt. / box
7 Pcs
1,931 m²
20,80 Kg



Qt. / Pal
85 box
164,135 m²
1.783 Kg



Rodapé Compatível
7cm - 2,20m

Ref.: RRDPWD2001

Cód.: **SP13/18.2 Unit**

18x152 - 6/0,55mm SPC
Já inclui a Tela/Manta colada na base

Série: **Essentials Marron - EIR**

Ref.: RSPCESS18152MAR

SP35/49



5 606779 253668

Underlay Included
Inclus la sous couche incorporer

VEJA O VÍDEO DE INSTALAÇÃO
CHECK THE INSTRUCTIONS VIDEO
REGARDEZ LA VIDEO D'INSTRUCTION
VEA EL VIDEO DE INSTRUCCIONES







High Traffic
&
Residential
0,55mm



Essentials Avelana



Qt. / box
7 Pcs
1,931 m²
20,80 Kg

Qt. / Pal
85 box
164,135 m²
1.783 Kg



Rodapé Compatível
7cm - 2,20m

Ref.: RRDPWD1004

Cód.: **SP13/18.2 Unit**

18x152 - 6/0,55mm SPC
Já inclui a Tela/Manta colada na base

Série: **Essentials Avelana - EIR**

Ref.: RSPCESS18152AVE

SP35/49



Underlay Included
Inclus la sous couche incorporer

VEJA O VÍDEO DE INSTALAÇÃO
CHECK THE INSTRUCTIONS VIDEO
REGARDEZ LA VIDEO D'INSTRUCTION
VEA EL VIDEO DE INSTRUCCIONES





EXPER
TASK SU
MOTIVATION
GOALS
SKILL
EFFORT
OUTCOME
TEA
PROCES
COOPERATIO



High Traffic
&
Residential
0,55mm



Essentials Ceniza



Qt. / box
7 Pcs
1,931 m²
20,80 Kg



Qt. / Pal
85 box
164,135 m²
1.783 Kg



Rodapé Compatível
7cm - 2,20m

Ref.: RRDPWD1009

Cód.: **SP13/18.2 Unit**

18x152 - 6/0,55mm SPC
Já inclui a Tela/Manta colada na base

Série: **Essentials Ceniza - EIR**

Ref.: RSPCESS18152CEN

SP35/49



Underlay Included
Inclus la sous couche incorporer

VEJA O VÍDEO DE INSTALAÇÃO
CHECK THE INSTRUCTIONS VIDEO
REGARDEZ LA VIDEO D'INSTRUCTION
VEA EL VIDEO DE INSTRUCCIONES







High Traffic
&
Residential
0,55mm

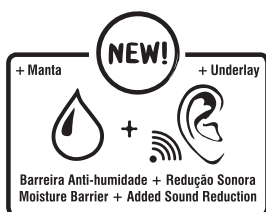

Impress Icarus



Qt. / box
7 Pcs
1,931 m²
20,80 Kg

Qt. / Pal
85 box
164,135 m²
1.783 Kg



Rodapé Compatível
7cm - 2,20m

Ref.: RRDPWD1005

Cód.: **SP13/18.2 Unit**



Rodapé Branco
7cm - 2,20m

Ref.: RRDPTH003

Cód.: **SP12/16.8 Unit**

18x152 - 6/0,55mm SPC
Já inclui a Tela/Manta colada na base

SP35/49

Série: **Impress Icarus - EIR**

Ref.: RSPCIM18152ACA



5 606779 266774

Underlay Included
Inclus la sous couche incorporer

VEJA O VÍDEO DE INSTALAÇÃO
CHECK THE INSTRUCTIONS VIDEO
REGARDEZ LA VIDEO D'INSTRUCTION
VEA EL VIDEO DE INSTRUCCIONES







High Traffic
&
Residential
0,55mm



Impress Acacia



Qt. / box
7 Pcs
1,931 m²
20,80 Kg



Qt. / Pal
85 box
164,135 m²
1.783 Kg



Rodapé Compatível
7cm - 2,20m

Ref.: RRDPWD1004

Cód.: **SP13/18.2 Unit**

18x152 - 6/0,55mm SPC
Já inclui a Tela/Manta colada na base

Série: **Impress Acacia - EIR**

Ref.: RSPCIM18152ACA

SP35/49



5 606779 266781

Underlay Included
Inclus la sous couche incorporer

VEJA O VÍDEO DE INSTALAÇÃO
CHECK THE INSTRUCTIONS VIDEO
REGARDEZ LA VIDEO D'INSTRUCTION
VEA EL VIDEO DE INSTRUCCIONES

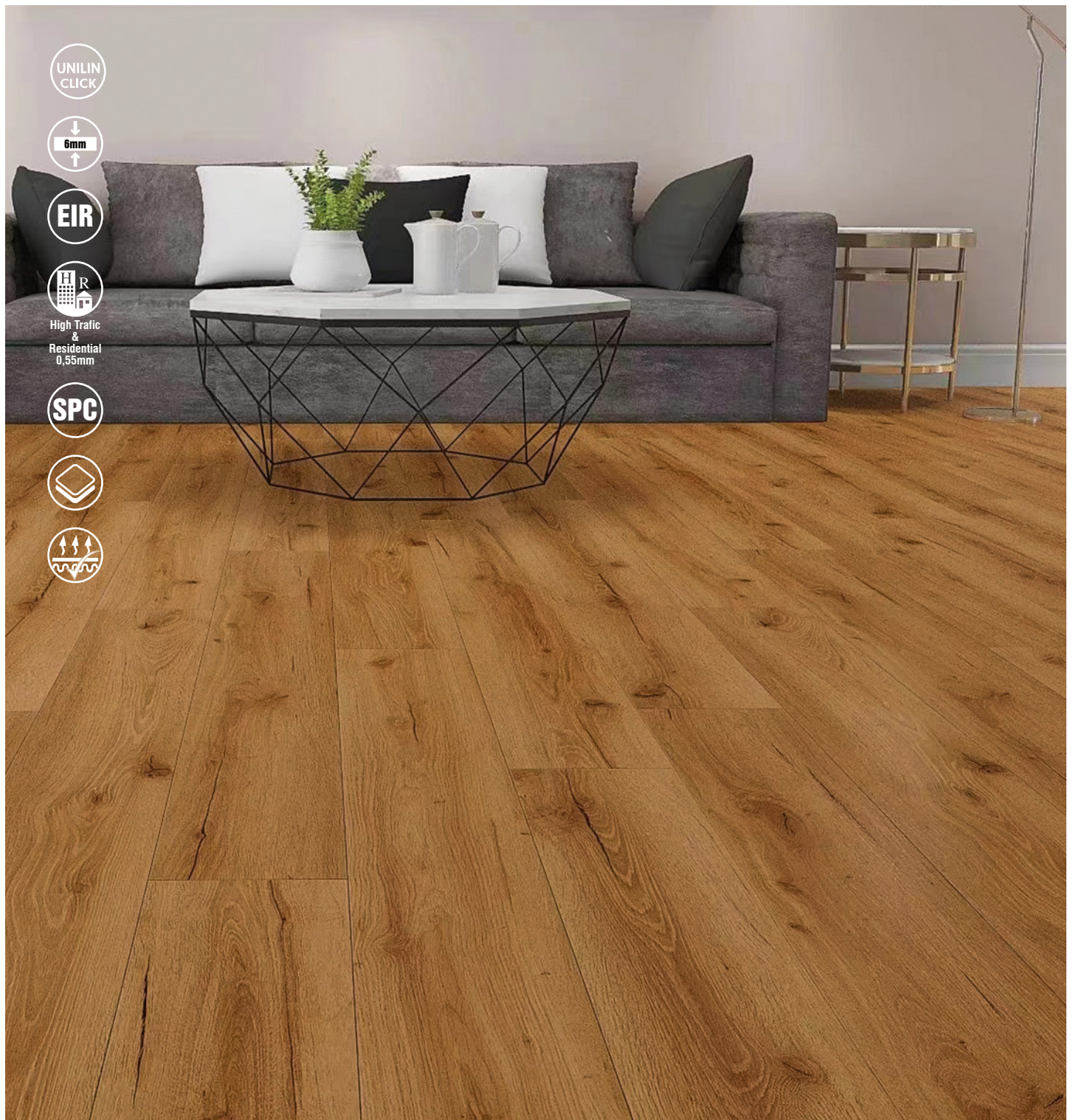

UNILIN
CLICK

6mm

EIR

High Traffic
&
Residential
0,55mm

SPC



Impress Roble

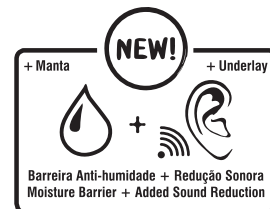

18x122cm - 6/0,55mm SPC - Já inclui a Tela/Manta colada na base

SP35/49

Série: **Pro Brown - EIR**

Ref.: **RSPCPR18122PRBR**



5 606779 206794

Underlay Included

Inclus la sous couche incorporer

Qt. / box	Qt. / Pal
10 Pcs	60 box
2,196 m ²	131,76 m ²
21 Kg	1.280 Kg



Rodapé Compatível
7cm - 2,20m

Ref.: **RRDPWD1002**

Cód.: **SP13/18.2 Unit**

VEJA O VÍDEO DE INSTALAÇÃO
CHECK THE INSTRUCTIONS VIDEO
REGARDEZ LA VIDEO D'INSTRUCTION
VEA EL VIDEO DE INSTRUCCIONES



UNILIN
CLICK

6mm

EIR

High Traffic
&
Residential
0,55mm

SPC

Wood Pinho

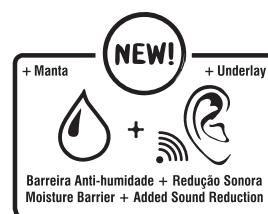

18x153cm - 6/0,55mm SPC - Já inclui a Tela/Manta colada na base

SP35/49

Série: **Wood Pinho - EIR**

Ref.: RSPC18153PI



5 606779 250889

Underlay Included

Inclus la sous couche incorporer

Qt. / box	Qt. / Pal
7 Pcs	60 box
1,966 m ²	117,98 m ²
19,80 Kg	1.170 Kg

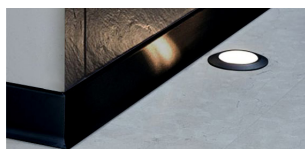

Rodapé Alumínio
8cm - 2,50m

Ref.: RA000R80NMT

Cód.: **SP22/31 Unit**

VEJA O VÍDEO DE INSTALAÇÃO
CHECK THE INSTRUCTIONS VIDEO
REGARDEZ LA VIDEO D'INSTRUCTION
VEA EL VIDEO DE INSTRUCCIONES







Wood Plus Multiformato



MULTIFORMATO
12,5 x 150cm
17,5 x 150cm
22,5 x 150cm
6mm / 0,55mm

Box A)	Box B)	Box C)
12,5cm	17,5cm	22,5cm
12 Pcs	6 Pcs	6 Pcs
2,25 m ²	1,575 m ²	2,025 m ²
23,50 Kg	16,20 Kg	21 Kg
Qt. / Pal	Qt. / Pal	Qt. / Pal
46 box	46 box	46 box
144,90 m ²	144,90 m ²	144,90 m ²
1.508 Kg	1.508 Kg	1.508 Kg



Rodapé Compatível
7cm - 2,20m

Ref.: RRDPWD1003

Cód.: SP13/18.2 Unit

12,5/17,5/17,5x150 - 6/0,55mm SPC
Já inclui a Tela/Manta colada na base

Série: **Wood Plus - EIR**

Ref.: RSPCMULTI150

SP35/49



5 606779 253552

Underlay Included
Inclus la sous couche incorporer

Artigo fornecido em Pack de 5 caixas por formato - Proporção: 1x A) + 2x B) + 2x C) = 9,45m²
Item supplied in Pack of 5 boxes per format - Proportion: 1x A) + 2x B) + 2x C) = 9,45sqm
Article fourni en Pack de 5 cartons par format - Proportion 1x A) + 2x B) + 2x C) = 9,45m²
Artículo suministrado en Pack de 5 cajas por formato - Proporción 1x A) + 2x B) + 2x C) = 9,45m²

VEJA O VÍDEO DE INSTALAÇÃO
CHECK THE INSTRUCTIONS VIDEO
REGARDEZ LA VIDEO D'INSTRUCTION
VEA EL VIDEO DE INSTRUCCIONES







High Traffic
&
Residential
0,55mm



Rodapé Compatível
7cm - 2,20m

Ref.: RRDPWD1002

Cód.: **SP13/18.2 Unit**



Herringbone



Qt. / box
28 Pcs
1,68 m²
16,67 Kg

Qt. / Pal
48 box
80,64 m²
800 Kg

10x60 - 6/0,55mm SPC

Já inclui a Tela/Manta colada na base

SP40/56

Série: **Herringbone Light - EIR**

Ref.: RSPC6010HE



5 606779 204059

Underlay Included
Inclus la sous couche incorporer



Rodapé Compatível
7cm - 2,20m

Ref.: RRDPWD1001

Cód.: **SP13/18.2 Unit**

Qt. / box
24 Pcs
1,89 m²
20,3 Kg

Qt. / Pal
60 box
113,4 m²
1218 Kg

12,7x62 - 6/0,55mm SPC

Já inclui a Tela/Manta colada na base

SP40/56

Série: **Herringbone Dark - EIR**

Ref.: RSPC6010HEDARK



5 606779 266705

Underlay Included
Inclus la sous couche incorporer

VEJA O VÍDEO DE INSTALAÇÃO
CHECK THE INSTRUCTIONS VIDEO
REGARDEZ LA VIDEO D'INSTRUCTION
VEA EL VIDEO DE INSTRUCCIONES



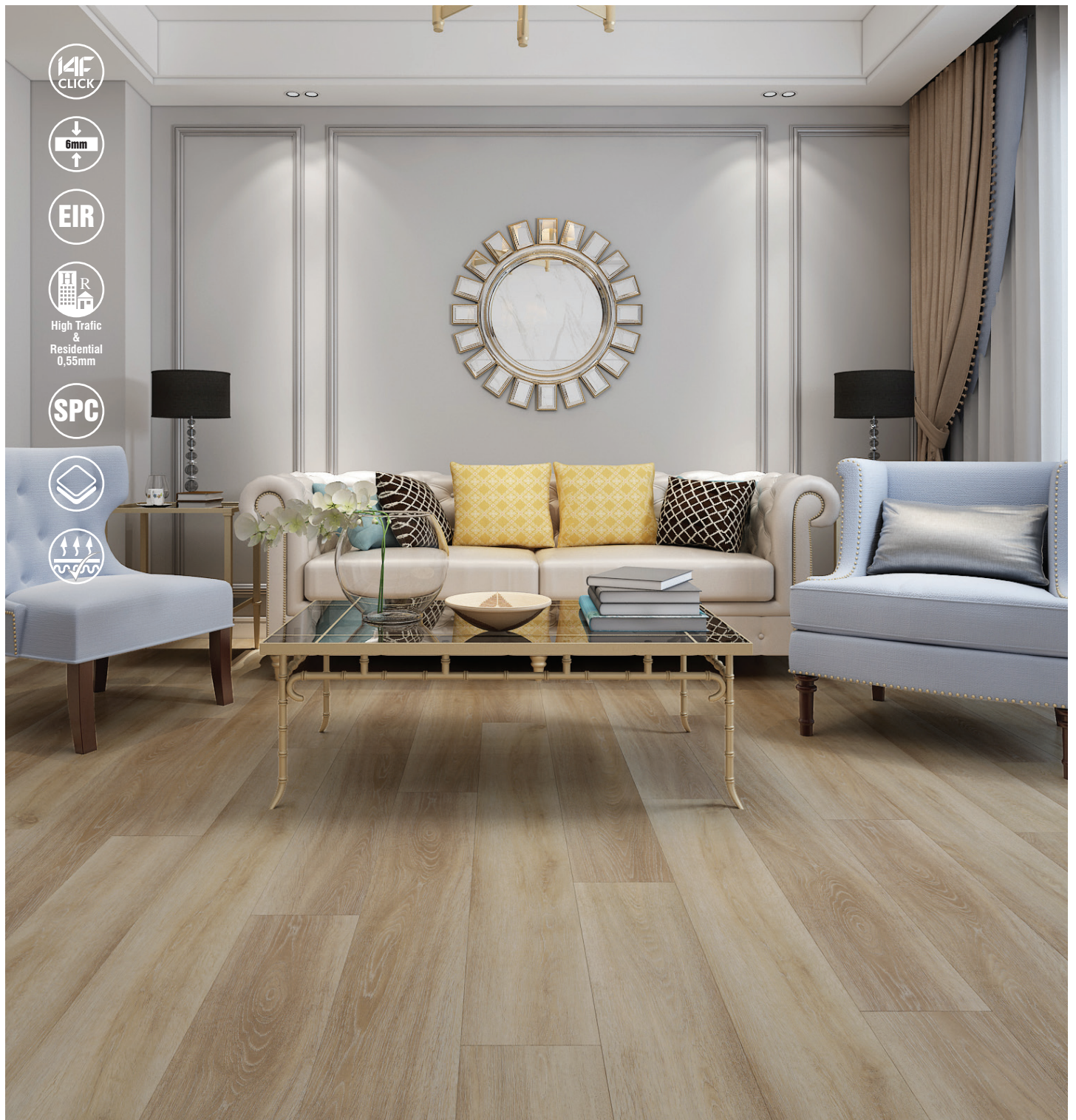

High Traffic
&
Residential
0,55mm



Premium Cream

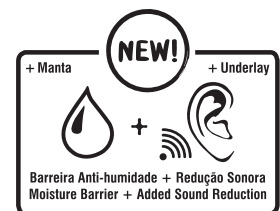

18x153cm - 6/0,55mm SPC - Já inclui a Tela/Manta colada na base

SP35/49

Série: Premium Cream - EIR

Ref.: RSPC18152PRCRETL



5 606779 206978

Underlay Included

Inclus la sous couche incorporer

Qt. / box	Qt. / Pal
8 Pcs	55 box
2,164 m ²	119,02 m ²
19 Kg	1060 Kg



Rodapé Compatível
7cm - 2,20m

Ref.: RRDPWD1010

Cód.: SP13/18.2 Unit

VEJA O VÍDEO DE INSTALAÇÃO
CHECK THE INSTRUCTIONS VIDEO
REGARDEZ LA VIDEO D'INSTRUCTION
VEA EL VIDEO DE INSTRUCCIONES





Premium Moka

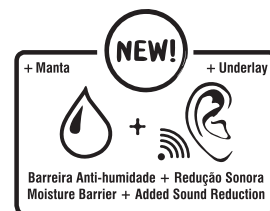

18x153cm - 6/0,55mm SPC - Já inclui a Tela/Manta colada na base

SP35/49

Série: **Premium Moka - EIR**

Ref.: RSPC18152PRMKTL



5 606779 206961

Underlay Included

Inclus la sous couche incorporer

Qt. / box	Qt. / Pal
8 Pcs	55 box
2,164 m ²	119,02 m ²
19 Kg	1060 Kg



Rodapé Compatível
7cm - 2,20m

Ref.: RRDPWD2002

Cód.: **SP13/18.2 Unit**

VEJA O VÍDEO DE INSTALAÇÃO
CHECK THE INSTRUCTIONS VIDEO
REGARDEZ LA VIDEO D'INSTRUCTION
VEA EL VÍDEO DE INSTRUCCIONES





Premium Milk

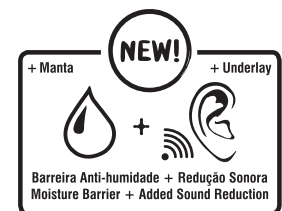

18x153cm - 6/0,55mm SPC - Já inclui a Tela/Manta colada na base

SP35/49

Série: **Premium Milk - EIR**

Ref.: **RSPC18152PRMILT**



Underlay Included

Inclus la sous couche incorporer

Qt. / box	Qt. / Pal
8 Pcs	55 box
2,164 m ²	119,02 m ²
19 Kg	1060 Kg



Rodapé Branco
7cm - 2,20m

Ref.: **RRDPWH003**

Cód.: **SP12/16.8 Unit**

VEJA O VÍDEO DE INSTALAÇÃO
CHECK THE INSTRUCTIONS VIDEO
REGARDEZ LA VIDEO D'INSTRUCTION
VEA EL VIDEO DE INSTRUCCIONES





Premium Cappuccino

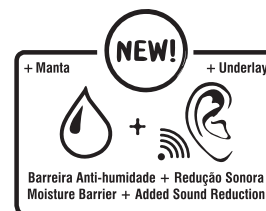

18x153cm - 6/0,55mm SPC - Já inclui a Tela/Manta colada na base

SP35/49

Série: **Premium Cappuccino - EIR**

Ref.: RSPC18152PRCAPTL



5 606779 206992

Underlay Included

Inclus la sous couche incorporer

Qt. / box	Qt. / Pal
8 Pcs	55 box
2,164 m ²	119,02 m ²
19 Kg	1060 Kg



Rodapé Compatível
7cm - 2,20m

Ref.: RRDPWD1010

Cód.: **SP13/18.2 Unit**

VEJA O VÍDEO DE INSTALAÇÃO
CHECK THE INSTRUCTIONS VIDEO
REGARDEZ LA VIDEO D'INSTRUCTION
VEA EL VÍDEO DE INSTRUCCIONES





Underlay Included
Inclus la sous couche incorporée



High Traffic
&
Residential
0,55mm



Habitat Olmo



Qt. / box
10 Pcs
2,763 m²
26,53 Kg



Qt. / Pal
50 box
135,234 m²
1.330 Kg



Rodapé Compatível
7cm - 2,20m

Ref.: RRDPWD1003

Cód.: **SP13/18.2 Unit**

18x153 - 6/0,55mm SPC
Já inclui a Tela/Manta colada na base

Série: **Habitat Olmo - EIR**

Ref.: RSPCHA18153OL

SP35/49



5 606779 204066

Underlay Included
Inclus la sous couche incorporer

VEJA O VÍDEO DE INSTALAÇÃO
CHECK THE INSTRUCTIONS VIDEO
REGARDEZ LA VIDEO D'INSTRUCTION
VEA EL VÍDEO DE INSTRUCCIONES





Habitat Amendoa

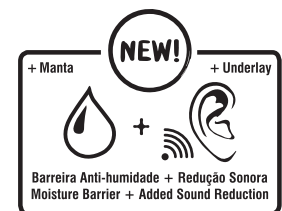

18x153cm - 6/0,55mm SPC - Já inclui a Tela/Manta colada na base

SP35/49

Série: **Habitat Amendoa - EIR**

Ref.: RSPCHAB18153AME



5 606779 204660

Underlay Included

Inclus la sous couche incorporer

Qt. / box	Qt. / Pal
6 Pcs	70 box
1,644 m ²	116 m ²
14,87 Kg	1000 Kg



Rodapé Compatível
7cm - 2,20m

Ref.: RRDPWD1005

Cód.: SP13/18.2 Unit

VEJA O VÍDEO DE INSTALAÇÃO
CHECK THE INSTRUCTIONS VIDEO
REGARDEZ LA VIDEO D'INSTRUCTION
VEA EL VIDEO DE INSTRUCCIONES





Habitat Gold Vanilla

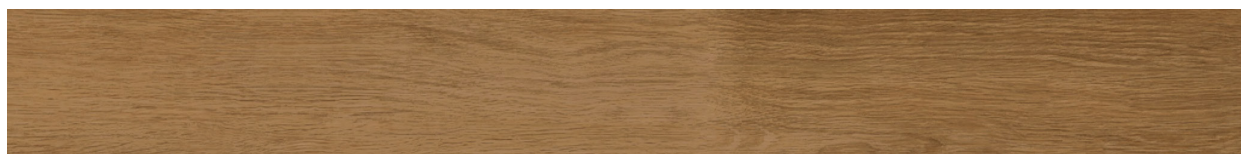
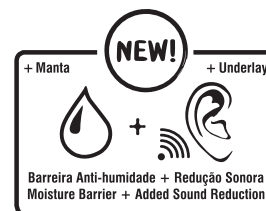

18x153cm - 6/0,55mm SPC - Já inclui a Tela/Manta colada na base

SP35/49

Série: **Habitat Gold Vanilla - EIR**

Ref.: RSPCHA18153GOVA



5 606779 209030

Underlay Included

Inclus la sous couche incorporer

Qt. / box	Qt. / Pal
6 Pcs	70 box
1,644 m ²	116 m ²
14,87 Kg	1000 Kg



Rodapé Compatível
7cm - 2,20m

Ref.: RRDPWD1003

Cód.: **SP13/18.2 Unit**

VEJA O VÍDEO DE INSTALAÇÃO
CHECK THE INSTRUCTIONS VIDEO
REGARDEZ LA VIDEO D'INSTRUCTION
VEA EL VÍDEO DE INSTRUCCIONES





High Traffic
&
Residential
0,55mm



Habitat Graphite

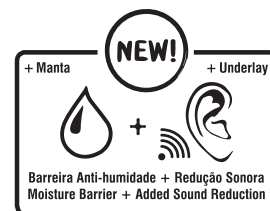

18x153cm - 6/0,55mm SPC - Já inclui a Tela/Manta colada na base

SP35/49

Série: **Habitat Graphite - EIR**

Ref.: **RSPCHA18153GRAF**



5 606779 209054

Underlay Included

Inclus la sous couche incorporer

Qt. / box	Qt. / Pal
6 Pcs	70 box
1,644 m ²	116 m ²
14,87 Kg	1000 Kg



Rodapé Branco
7cm - 2,20m

Ref.: **RRDPWH003**

Cód.: **SP13/18.2 Unit**

VEJA O VÍDEO DE INSTALAÇÃO
CHECK THE INSTRUCTIONS VIDEO
REGARDEZ LA VIDEO D'INSTRUCTION
VEA EL VIDEO DE INSTRUCCIONES





Habitat Violino

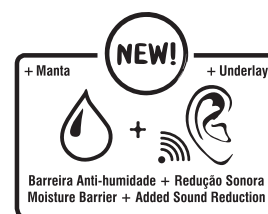

18x153cm - 6/0,55mm SPC - Já inclui a Tela/Manta colada na base

SP35/49

Série: **Habitat Violino - EIR**

Ref.: RSPCHA18153VIO



5 606779 209023

Underlay Included

Inclus la sous couche incorporer

Qt. / box	Qt. / Pal
6 Pcs	70 box
1,644 m ²	116 m ²
14,87 Kg	1000 Kg



Rodapé Compatível
7cm - 2,20m

Ref.: RRDPWD1003

Cód.: **SP13/18.2 Unit**

VEJA O VÍDEO DE INSTALAÇÃO
CHECK THE INSTRUCTIONS VIDEO
REGARDEZ LA VIDEO D'INSTRUCTION
VEA EL VIDEO DE INSTRUCCIONES





Pro Nordig

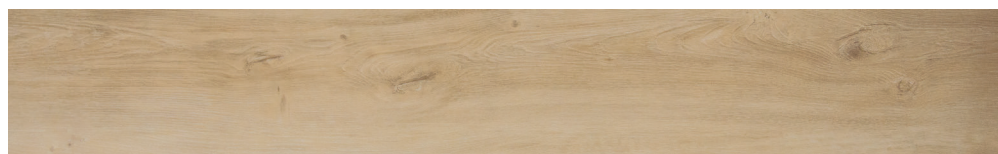
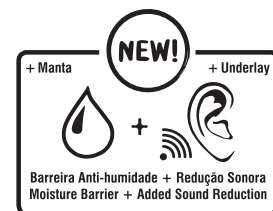

18x122cm - 6/0,55mm SPC - Já inclui a Tela/Manta colada na base

SP35/49

Série: **Pro Nordig - EIR**

Ref.: **RSPCPR18122NOR**



Underlay Included

Inclus la sous couche incorporer

Qt. / box	Qt. / Pal
10 Pcs	65 box
2,196 m ²	142,74 m ²
19,65 Kg	1,293 Kg



Rodapé Compatível
7cm - 2,20m

Ref.: **RRDPWD1004**

Cód.: **SP13/18.2 Unit**

VEJA O VÍDEO DE INSTALAÇÃO
CHECK THE INSTRUCTIONS VIDEO
REGARDEZ LA VIDEO D'INSTRUCTION
VEA EL VÍDEO DE INSTRUCCIONES





6mm

EIR

High Traffic
&
Residential
0,55mm

SPC



Pro Brown

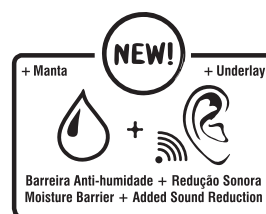

18x122cm - 6/0,55mm SPC - Já inclui a Tela/Manta colada na base

SP35/49

Série: **Pro Brown - EIR**

Ref.: RSPCPR18122PRBR



Underlay Included
Inclus la sous couche incorporer

Qt. / box	Qt. / Pal
10 Pcs	65 box
2,196 m ²	142,74 m ²
19,65 Kg	1.293 Kg



Rodapé Compatível
7cm - 2,20m

Ref.: RRDPWD2001

Cód.: **SP13/18.2 Unit**

VEJA O VÍDEO DE INSTALAÇÃO
CHECK THE INSTRUCTIONS VIDEO
REGARDEZ LA VIDEO D'INSTRUCTION
VEA EL VIDEO DE INSTRUCCIONES





High Traffic
&
Residential
0,55mm

SPC

Pro Grey

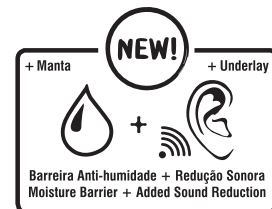

18x122cm - 6/0,55mm SPC - Já inclui a Tela/Manta colada na base

SP35/49

Série: **Pro Grey - EIR**

Ref.: **RSPCPRI8122GRE**



Underlay Included
Inclus la sous couche incorporer

Qt. / box	Qt. / Pal
10 Pcs	65 box
2,196 m ²	142,74 m ²
19,65 Kg	1,293 Kg



Rodapé Branco
7cm - 2,20m

Ref.: **RRDPWH003**

Cód.: **SP12/16.8 Unit**

VEJA O VÍDEO DE INSTALAÇÃO
CHECK THE INSTRUCTIONS VIDEO
REGARDEZ LA VIDEO D'INSTRUCTION
VEA EL VIDEO DE INSTRUCCIONES



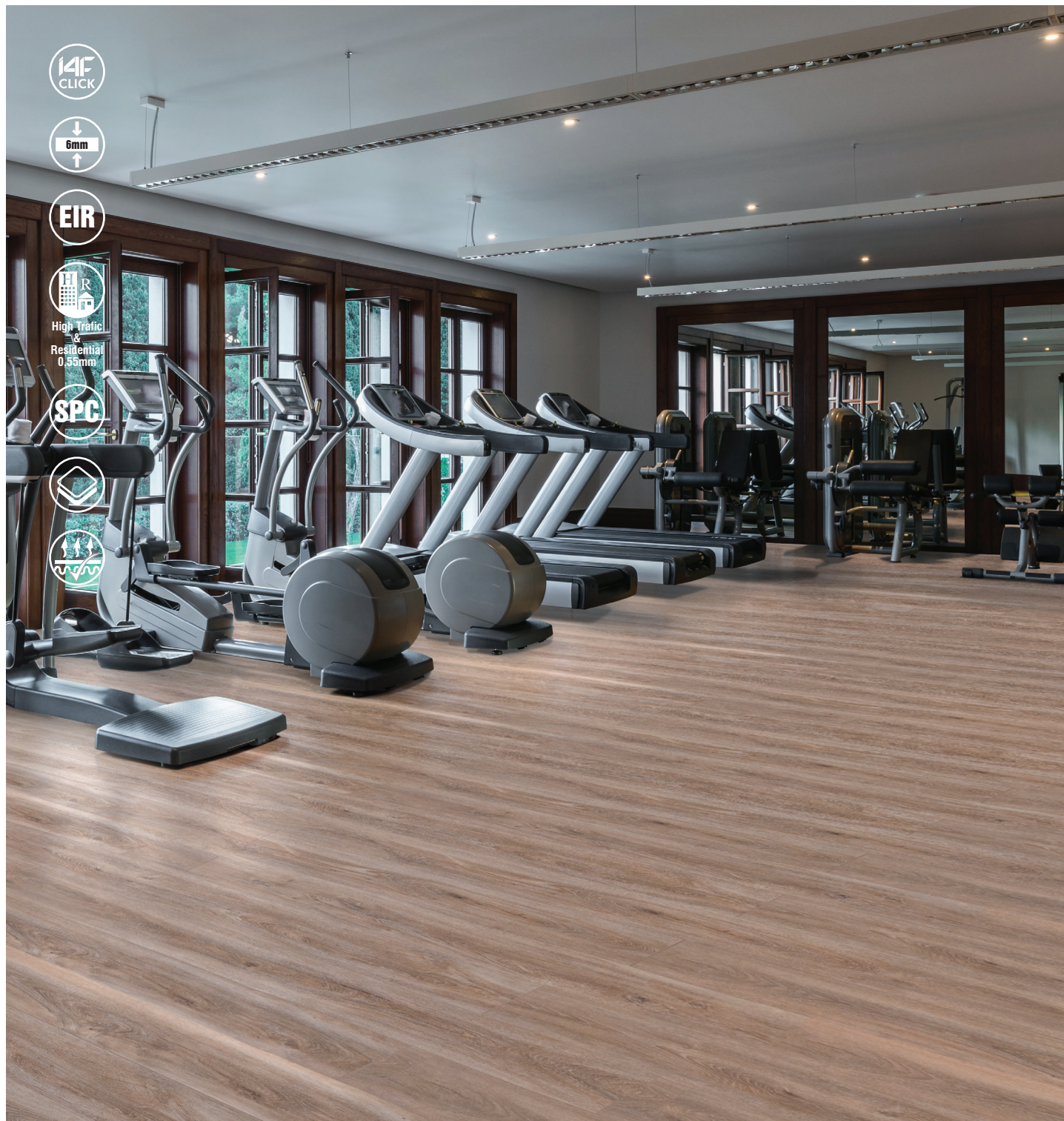

Pro Caramel

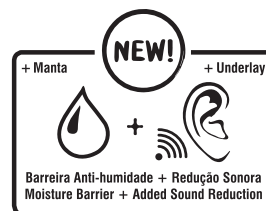

18x122cm - 6/0,55mm SPC - Já inclui a Tela/Manta colada na base

SP35/49

Série: **Pro Caramel - EIR**

Ref.: RSPCPR18122CAR



5 606779 204677

Underlay Included

Inclus la sous couche incorporer

Qt. / box	Qt. / Pal
10 Pcs	65 box
2,196 m ²	142,74 m ²
19,65 Kg	1.293 Kg



Rodapé Compatível
7cm - 2,20m

Ref.: RRDPWD1003

Cód.: **SP13/18.2 Unit**

VEJA O VÍDEO DE INSTALAÇÃO
CHECK THE INSTRUCTIONS VIDEO
REGARDEZ LA VIDEO D'INSTRUCTION
VEA EL VIDEO DE INSTRUCCIONES



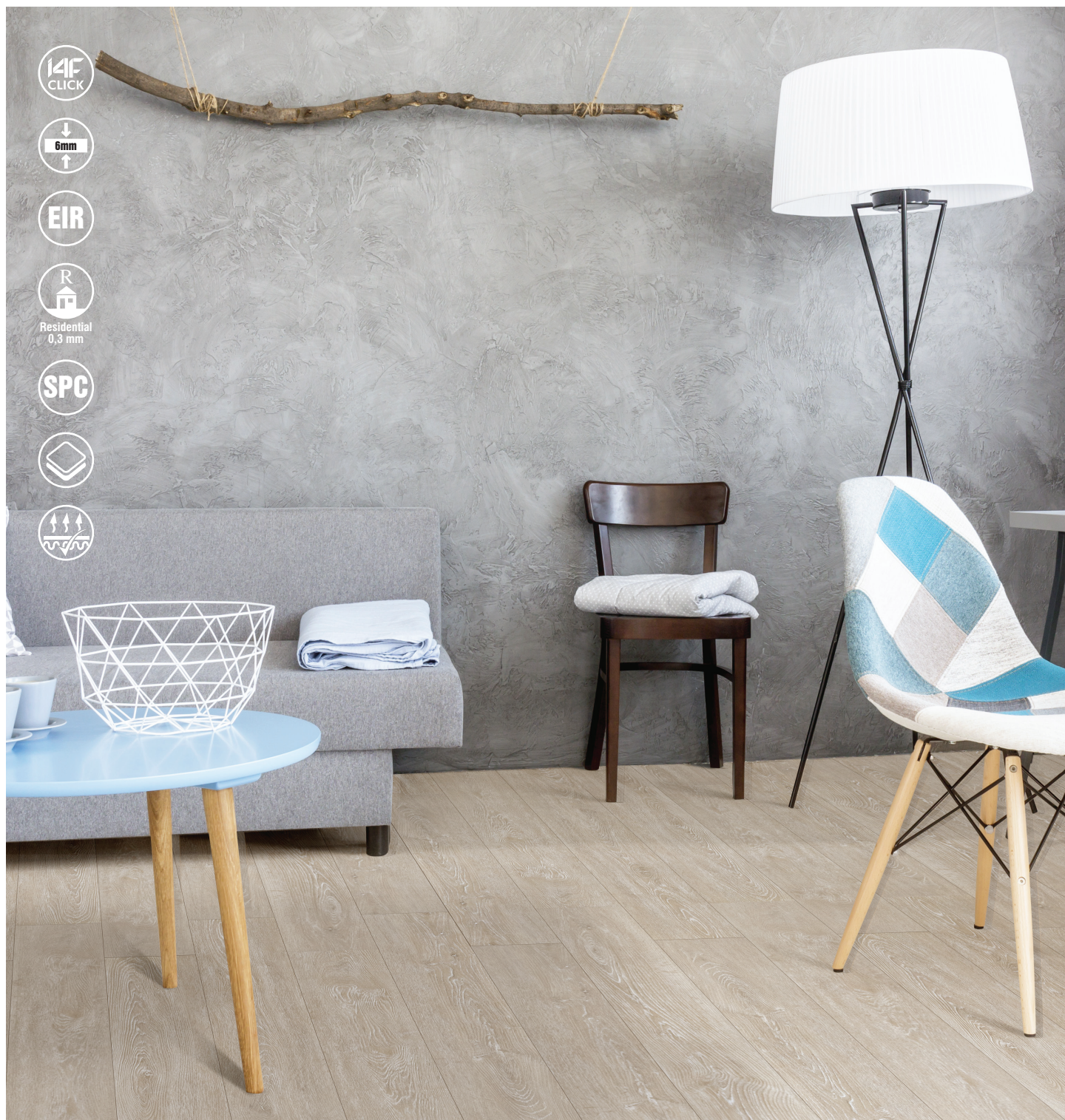

Loft Ivory

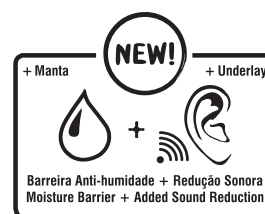

18x122cm - 6/0,5mm SPC - Já inclui a Tela/Manta colada na base

SP35/49

Série: **Loft Ivory - EIR**

Ref.: RSPC18122LI6



5 606779 254054

Underlay Included

Inclus la sous couche incorporer

Qt. / box	Qt. / Pal
10 Pcs	70 box
2,196 m ²	153,72 m ²
17,73 Kg	1256 Kg



Rodapé Compatível
7cm - 2,20m

Ref.: RRDPWD1005

Cód.: SP13/18.2 Unit

VEJA O VÍDEO DE INSTALAÇÃO
CHECK THE INSTRUCTIONS VIDEO
REGARDEZ LA VIDEO D'INSTRUCTION
VEA EL VIDEO DE INSTRUCCIONES





Loft Ash

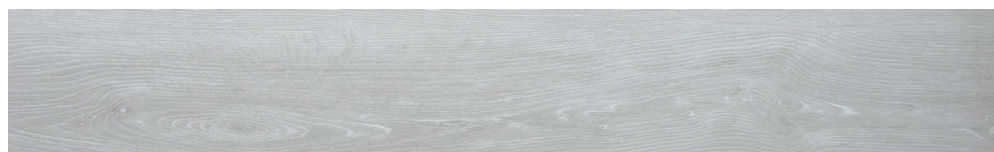
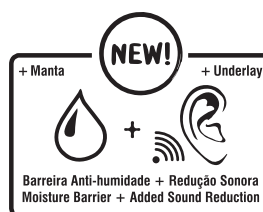

18x122cm - 6/0,5mm SPC - Já inclui a Tela/Manta colada na base

SP35/49

Série: **Loft Ash - EIR**

Ref.: **RSPC18122LATE6**



5 606779 253613

Underlay Included

Inclus la sous couche incorporer

Qt. / box	Qt. / Pal
10 Pcs	70 box
2,196 m ²	153,72 m ²
17,73 Kg	1256 Kg



Rodapé Branco
7cm - 2,20m

Ref.: **RRDPWD1009**

Cód.: **SP13/18.2 Unit**

VEJA O VÍDEO DE INSTALAÇÃO
CHECK THE INSTRUCTIONS VIDEO
REGARDEZ LA VIDEO D'INSTRUCTION
VEA EL VIDEO DE INSTRUCCIONES







High Traffic
&
Residential
0,55mm



Qt. / box
10 Pcs
2,196 m²
17,73 Kg



Qt. / Pal
70 box
153,72 m²
1.256 Kg



Rodapé Compatível
7cm - 2,20m

Ref.: RRDPWD1003

Cód.: **SP13/18.2 Unit**

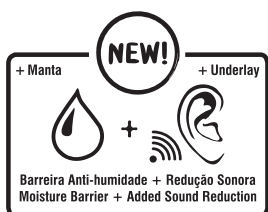

Loft Honey



18x122cm - 6/0,5mm SPC
Já inclui a Tela/Manta colada na base

SP35/49

Série: **Loft Honey - EIR**

Ref.: RSPC18122LH6



5 606779 254047

Underlay Included
Inclus la sous couche incorporer

VEJA O VÍDEO DE INSTALAÇÃO
CHECK THE INSTRUCTIONS VIDEO
REGARDEZ LA VIDEO D'INSTRUCTION
VEA EL VÍDEO DE INSTRUCCIONES







Wall Pro

ESPECIAL FAÇA VOCÊ MESMO - DIY

PLACAS AUTO-ADESIVAS DE SPC EXCLUSIVAMENTE PARA PAREDES
 SELF-ADHESIVE SPC TILES EXCLUSIVELY FOR WALLS
 DALLETES AUTO-ADHÉSIVES EN SPC EXCLUSIVEMENT POUR MURS
 LOSETAS AUTOADHESIVAS EN SPC EXCLUSIVAMENTE PARA PAREDES

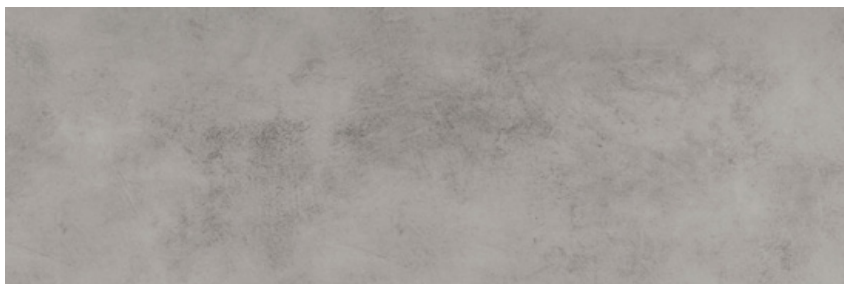

30,5x91,5cm SPC

SP32/45

Série: **Wall Pro Silver**

Ref.: RWP305915SIL



5 606779 191786

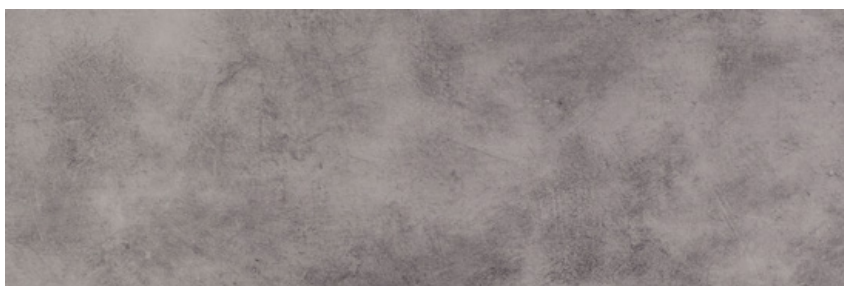

30,5x91,5cm SPC

SP32/45

Série: **Wall Pro Griggio**

Ref.: RWP305915GRI



5 606779 191793

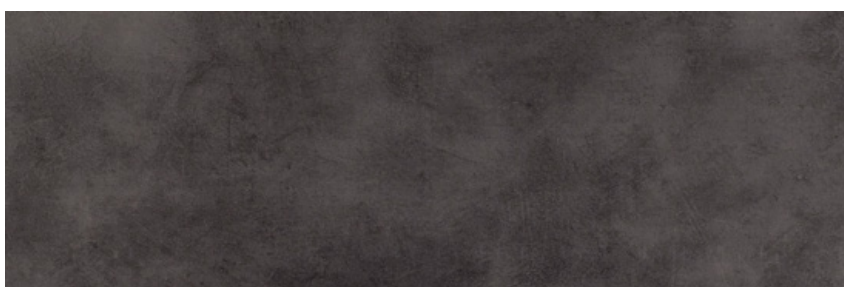

30,5x91,5cm SPC

SP32/45

Série: **Wall Pro Dark Grey**

Ref.: RWP305915DARKGRE



5 606779 191809

Qt. / box	Qt. / Pal
10 Pcs	48 box
2,79 m ²	133,92 m ²
18,98 Kg	926 Kg

VEJA O VÍDEO DE INSTALAÇÃO
 CHECK THE INSTRUCTIONS VIDEO
 REGARDEZ LA VIDEO D'INSTRUCTION
 VEA EL VÍDEO DE INSTRUCCIONES



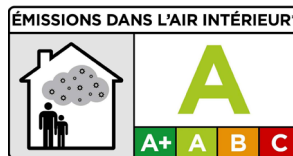
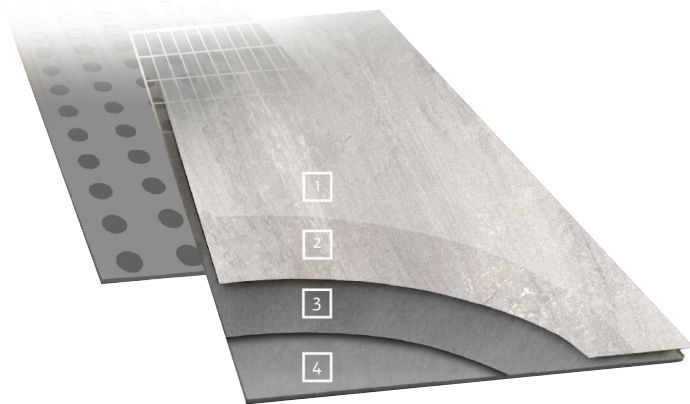

PLACAS AUTO-ADESIVAS DE VINIL PARA PAREDES

1. Camada protetora em PU de alta resistência
2. Película em PVC decorativo de alta definição
3. Base de compostos minerais
4. Espuma eva auto-adesiva com espaços para aplicação de silicone

SELF-ADHESIVE VINYL TILES FOR WALLS

1. High resistance PU overlay protector
2. High definition pvc laminate
3. Mineral compound base
4. Self-adhesive eva foam with space to apply silicone

DALLETES AUTOCOLLANTES EN VINYLE POUR MURS

1. Haute résistance PU revêtement protecteur
2. Haute définition PVC laminé
3. Base fibre minérale
4. Mousse EVA auto-adhésif avec emplacement pour application de silicone

LOSETAS AUTOADHESIVAS DE VINILO PARA PAREDES

1. Capa protectora em PU de alta resistencia
2. Lámina decorativa de PVC de alta definición
3. Base de fibras minerales
4. Espuma EVA autoadhesiva con reservas para aplicación de silicona

Wall Pro DIY SPECIAL



SELF ADHESIVE

Can be installed on almost any type of surface.
AUTO ADESIVO
Pode ser aplicado em quase qualquer tipo de parede.

AUTO-ADHÉSIF
Installez directement les plaques sur la quasi-totalité de les surfaces.
AUTOADHESIVO
Instale directamente las placas en casi cualquier superficie.



100% WATER RESISTANT

Special compound of water-resistant mineral compound.

100% RESISTENTE À ÁGUA
Com composto especial de minerais resiste 100% à água.
L'HUMIDITÉ
Avec composant séciel en minéral résiste à léau.

100% RESISTENTE A LA HUMIDAD
Con un compuesto especial de minérale resiste al agua.



EASY TO CUT

Can be cut into any shape using just a cutter.
FÁCIL DE CORTAR
Apenas com um simples X-Acto pode ser cortado em qualquer forma.

FACILE A DÉCOUPER
Avec un simple cutter vous pourrez faire une découpe dans la plaque.

FÁCIL DE CORTAR
Con sólo un cutter podrá realizar cualquier corte en la placa.



EXTRA-THIN

Only 5.5mm thickness. No wall space wasted.
EXTRA FINO
Só 5,5mm de espessura. Não perderá espaço nas suas paredes.

EXTRA-FIN
Seulement 5.5mm de épaisseur. Ne prendra pas de place sur votre mur
EXTRA-FINO
Solo 5.5mm de grosor. No perderá espacio en sus paredes.



KNOCK RESISTANT

Most Wall coverings are fragile. Our tiles are more knock-resistant.
RESISTENTE AOS IMPACTOS
A maioria dos revestimentos são frágeis aos impactos.

As nossas placas são altamente resistentes.
RÉSISTENT AUX COUPS
La plupart des revêtements sont sensibles à l'impact. Nos plaques résistent mieux aux coups.
RESISTENTE A LOS GOLPES
La mayoría de revestimientos son frágiles al impacto. Nuestras placas resisten mejor los golpes.



NO CONSTRUCTION WORK

Installation of our tiles won't cause any dust, noise or any type of mess at all.
SEM OBRAS

A instalação das nossas placas não gera pó, ruídos nem resíduos.
SANS TRAVAUX
L'installation de nos plaques ne produit pas de poussière, bruit ni de résidus
SIN OBRAS
La instalación de nuestras placas no genera polvo, ruidos ni residuos.



THERMAL AND SOUND INSULATION

Improve temperature and sound insulation of walls with our tiles.

ISOLANTE ACÚSTICO E TÉRMICO
Melhora a temperatura e o isolamento acústico das suas paredes com as nossas placas.
ISOLANT THERMIQUE ET ACOUSTIQUE
Améliorez la température et l'isolation acoustique de vos murs avec nos plaques WALL PRO.
AISLANTE TÉRMICO Y ACÚSTICO
Mejora la temperatura y el aislamiento acústico de sus paredes con nuestras placas.



LIGHT AND EASY TO MANAGE

Only 700g/tile, 3,5Kg/m². Easy to install and carry.
LEVE E MANUSEÁVEL
Só 700g/placa, 3,5Kg/m².

Fácil de instalar e de manusear.
LÉGER ET MANÉABLE
Seulement 700g/plaque, 3,5Kg/m². Facile à installer et à transporter.
LIGERO Y MANEJABLE
Solo 700gr/placa, 3,5Kg/m². Fácil de instalar y transportar.



FIRE PROOF

Fire behavior test result: C-s2,d0
À PROVA DE FOGO
Resultado do teste de comportamento de incêndio: C-s2,d0
ÉPREUVE DU FEU
Résultat du test de comportement au feu: C-s2,d0
A PRUEBA DE FUEGO
Resultado de la prueba de comportamiento del fuego: C-s2,d0

TESTE / TEST

RESULTADO RESULTS

Espuma de baixa densidade: espessura (mm) / densidade (kg / m ³) / Low density foam: thickness (mm) / density (kg/m ³)	1,5 mm / 33 kg/m ³
Espuma de alta densidade: espessura (mm) / densidade (kg / m ³) / High density foam: thickness (mm) / density (kg/m ³)	1,5 mm / 110 kg/m ³
Núcleo: placa de fibra mineral: espessura (mm) / densidade (kg / m ³) Core: mineral fiber board: thickness (mm) / density (kg/m ³)	3 mm / 1000 kg/m ³
Protetor de sobreposição de PU / PU overlay protector	1mm
Bisel / Bevel	Bisel V pintado - 4 lados Painted V Bevel - 4 sides
Solidez da cor à luz / Colour fastness to light ISO105 Bo2	4 - 5
Estabilidade Dimensional / Dimensional stability ISO23999:2012	0,10%
Expansão na mudança de temperatura de 23°C to 45°C / Expansion in temperature change from 23°C to 45°C	0,010%
Encolhimento na mudança de temperatura de 23°C to 5°C / Shrinkage in temperature change from 23°C to 5°C	-0,047%
Ondulação Após Exposição / Curling after exposure ISO23999:2012	0 mm.
Comportamento ao Fogo / Fire behavior UNE-EN 13823:2012	C-s2,d0
Emissões de formaldeído / Formaldehyde emissions EN717-1:2004	PASS
Dilatação na espessura / Swelling in thickness EN317:1993	1%
Determinação do recuo residual / Determination of residual indentation EN ISO24343-1	0,04mm
Teste de emissões de VOC / VOC emissions testing ISO:16000 / 3,6,9,11	A

Wall Pro DIY SPECIAL

3

Passos simples para instalar Wall Pro
 Simple steps to install Wall Pro
 3 étapes simples pour installer le Wall Pro
 Sencillos pasos para instalar Wall Pro
 Einfache Schritte zur Installation von Wall Pro

Como colar?

How to paste? Comment coller? Como pegar? Wie einfügen?

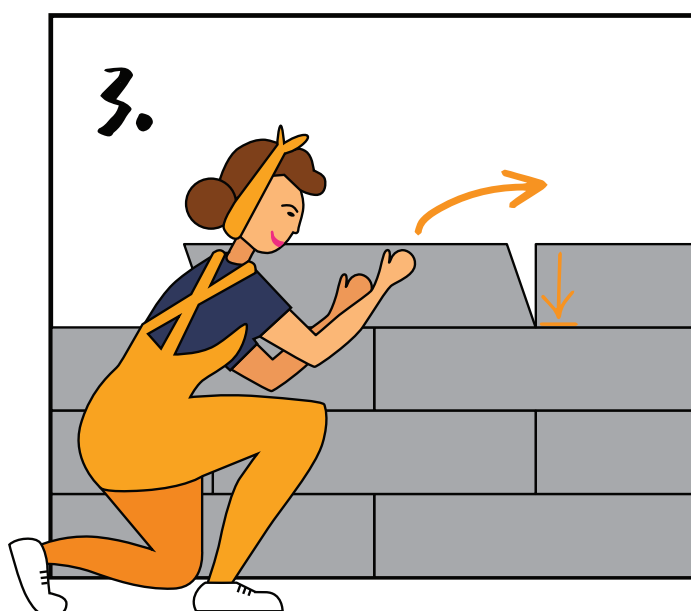
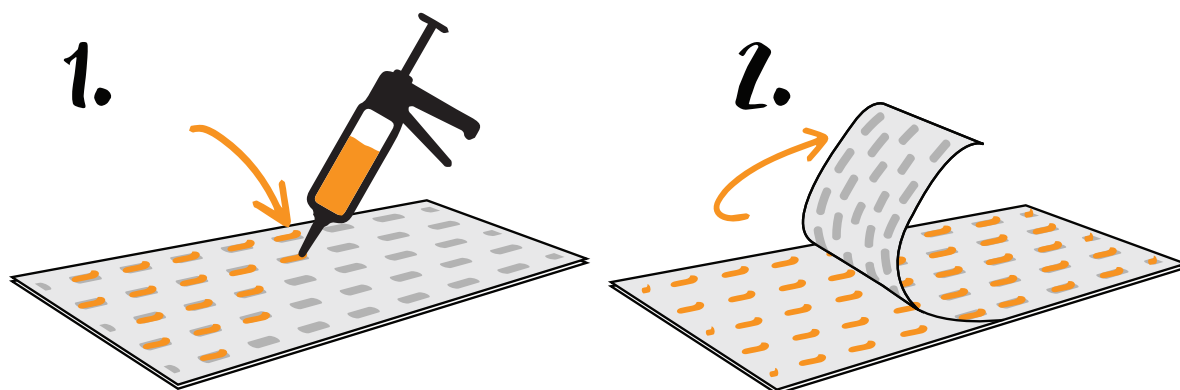

Como cortar?

How to cut? Comment coupe? Como cortar? Wie schneide ich?

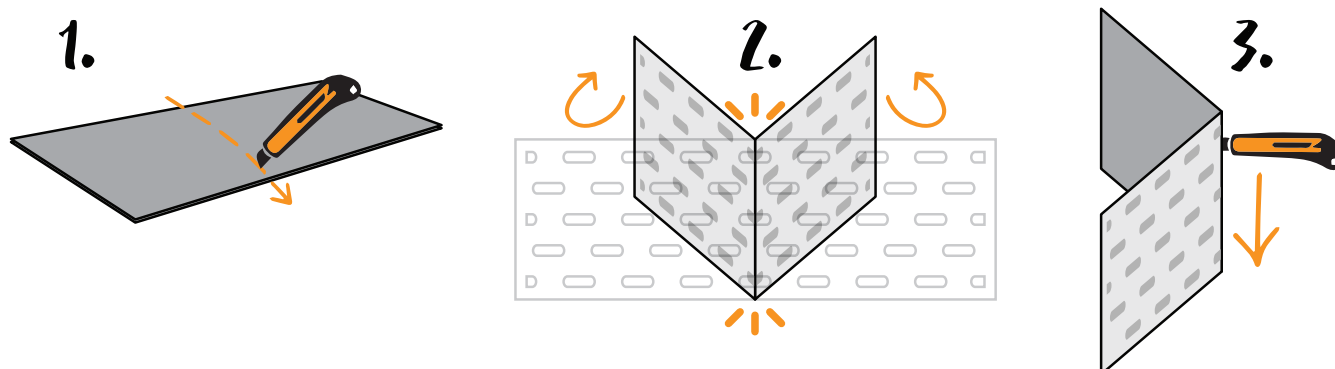



ACESSÓRIOS
Accessories / Accessoires
Accesorios / Zubehör

Rodapé PVC

PVC skirting / Plinthe de PVC



Rodapé PVC Branco

White PVC skirting
Plinthe Blanc de PVC

SP12/16.8 Unit

Dim.: **2,20m / 7cm**

Ref.: **RRDPWH003**

Compatível com todas as referências de SPC Rubicer



Rodapé PVC

PVC skirting / Plinthe de PVC

SP13/18.2 Unit

Dim.: **2,20m / 7cm**

Ref.: **RRDPWD1002**

Compatível com as séries: Impress Roble, Herringbone, Essentials Avelana, Essentials Oak



Rodapé PVC

PVC skirting / Plinthe de PVC

SP13/18.2 Unit

Dim.: **2,20m / 7cm**

Ref.: **RRDPWD1003**

Compatível com as séries: Habitat Olmo, Violino, GoldVanilla, Pro Caramel, Wood-Plus

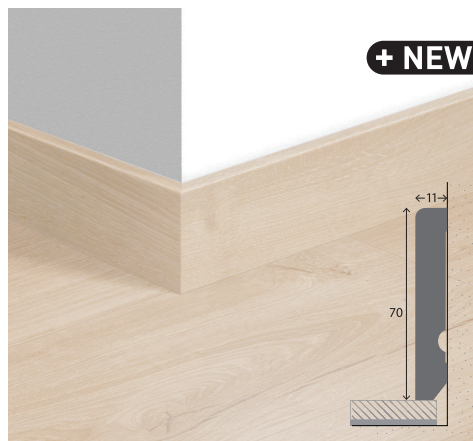

Rodapé PVC

PVC skirting / Plinthe de PVC

SP12/16.8 Unit

Dim.: **2,20m / 7cm**

Ref.: **RRDPWD1004**

Compatível com as séries: Loft Honey, Pro Nordig, XL1.8 Beach

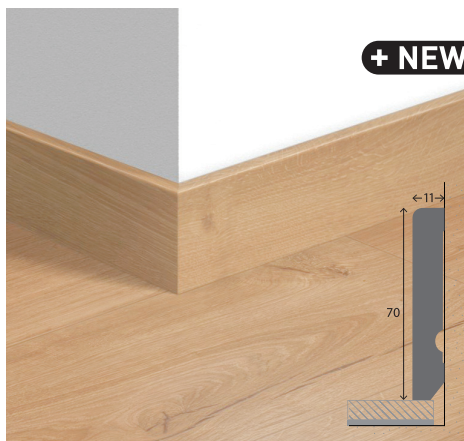

Rodapé PVC

PVC skirting / Plinthe de PVC

SP13/18.2 Unit

Dim.: **2,20m / 7cm**

Ref.: **RRDPWD1005**

Compatível com as séries: Habitat Amendoa, Loft Ivory

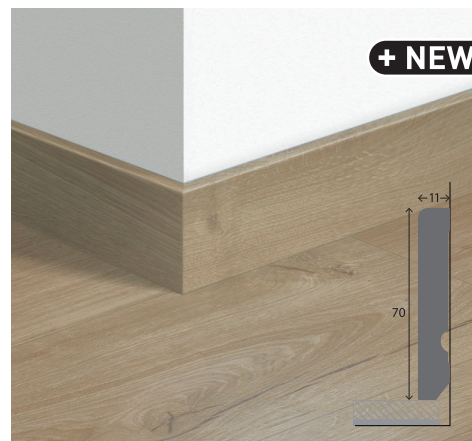

Rodapé PVC

PVC skirting / Plinthe de PVC

SP13/18.2 Unit

Dim.: **2,20m / 7cm**

Ref.: **RRDPWD1010**

Compatível com as séries: Premium Cream, Premium Cappuccino, XL1.8 Country

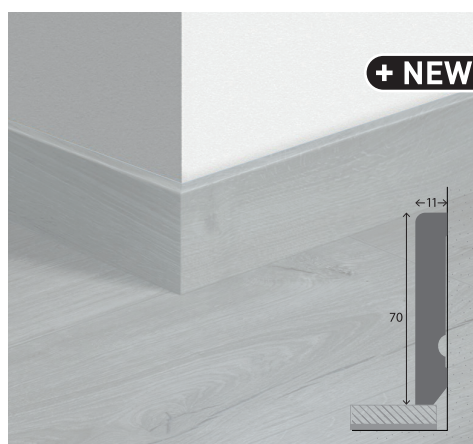

Rodapé PVC

PVC skirting / Plinthe de PVC

SP12/16.8 Unit

Dim.: **2,20m / 7cm**

Ref.: **RRDPWD1009**

Compatível com as séries: Loft Ash

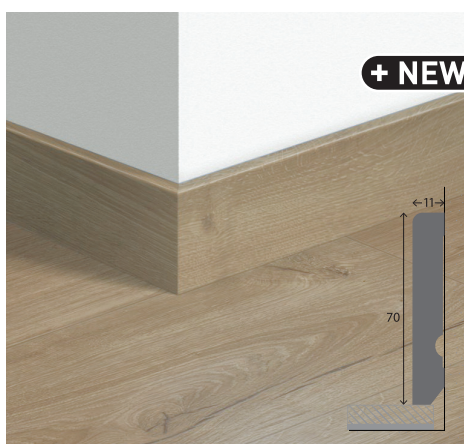

Rodapé PVC

PVC skirting / Plinthe de PVC

SP13/18.2 Unit

Dim.: **2,20m / 7cm**

Ref.: **RRDPWD2002**

Compatível com as séries: Premium Moka



Rodapé PVC

PVC skirting / Plinthe de PVC

SP13/18.2 Unit

Dim.: **2,20m / 7cm**

Ref.: **RRDPWD2001**

Compatível com as séries: Pro Brown, Essentials Marron



TAPIS DE PROTECTION

La solution parfaite pour protéger votre sol contre les dommages causés par les roulettes des chaises de bureau, sans affecter l'effet esthétique de votre sol.

Ce tapis PPH transparent a été développé pour éviter l'usure des sols durs tels que : bois, vinyle, céramique, flottant, stratifié et SPC.



+ NEW

TAPETE PROTECTOR

A solução perfeita para a proteger o seu chão contra os danos causados pelas rodas das cadeiras de escritório, sem afectar o efeito estético do seu pavimento.

Este tapete em PPH transparente foi desenvolvido para combater o desgaste dos pavimentos duros como: madeira, pisos vinílicos, cerâmica, flutuante, estratificado e pisos SPC.

Tapete Protector

Protective mat / Tapis protecteur **SP35/49 Unit**Dim.: **120x100cm - 1,5mm**

Ref.: RTP100120PPT



5 606779 254313

Rodapé ALUMÍNIO

ALUMINIUM skirting / Plinthe de ALUMINIUM / Rodapié de ALUMINIO



+ NEW



+ NEW



+ NEW

Rodapé Alumínio

Alu skirting / Plinthe de Aluminium **SP22/31 Unit**Dim.: **2,50m / 8cm**

Ref.: RA000R80PMT



5 606779 252593

Rodapé Alumínio

Alu skirting / Plinthe de Aluminium **SP22/31 Unit**Dim.: **2,50m / 8cm**

Ref.: RA000R80BRAMT



5 606779 252623

Rodapé Alumínio

Alu skirting / Plinthe de Aluminium **SP22/31 Unit**Dim.: **2,50m / 8cm**

Ref.: RA000R80NMT



5 606779 252609

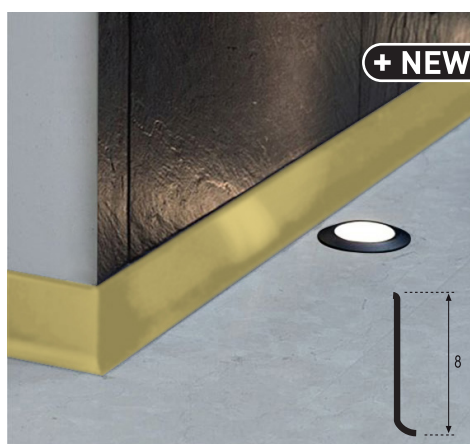

+ NEW

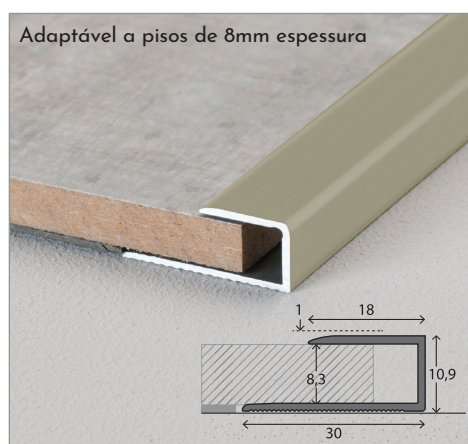

Adaptável a pisos de 8mm espessura

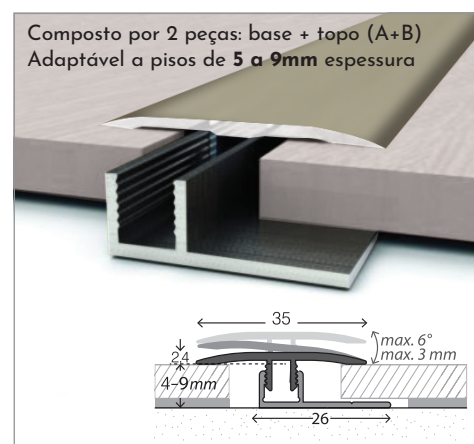
Composto por 2 peças: base + topo (A+B)
Adaptável a pisos de 5 a 9mm espessura

Rodapé Alumínio

Alu skirting / Plinthe de Aluminium **SP22/31 Unit**Dim.: **2,50m / 8cm**

Ref.: RA000R80OMT



5 606779 252616

Terminal de rebordo

Edge trim / Profilé à bord **PV25/35**Dim.: **2,70m**

Ref.: RFLT33807ALUBRO



5 606779 209146

Transição - autocolante

Connection section / Profilé de jonction **PV35/49**Dim.: **2,70m**

Ref.: RFLT5107ALUBRO



5 606779 209115



Terminal Degrau
Stair nosing
Perfilé nez-de-marche

PV30/42Dim.: **2,50m**Ref.: **RLVT176131125**

Terminal Degrau C/ Led
LED stair nosing
Perfilé nez-de-marche

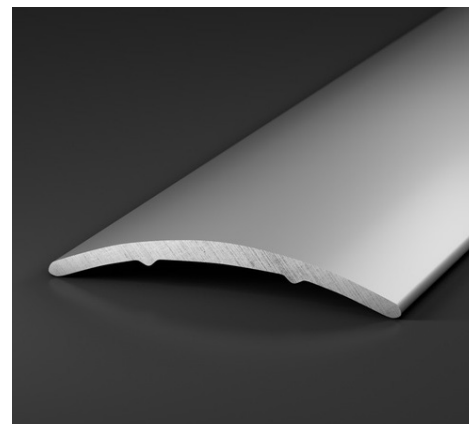
PV70/98Dim.: **2,50m**Ref.: **RLVT218131125**

Transição - autocolante
Connection section
Perfilé de jonction

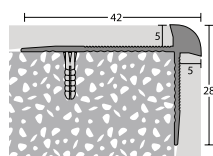
PV25/35Dim.: **2,70m**Ref.: **RLVT1302411**

Terminal Degrau
Stair nosing
Perfilé nez-de-marche

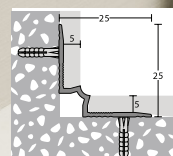
PV37.5/52.5Dim.: **2,50m**Ref.: **RLVT18813**

Terminal Degrau
Stair nosing inner angle
Perfilé nez-de-marche

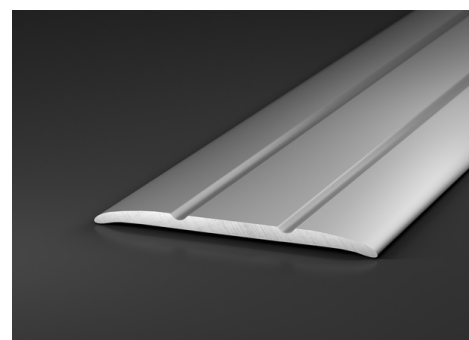
PV30/42Dim.: **2,50m**Ref.: **RLVT1061311**

Transição - autocolante
Connection section
Perfilé de jonction

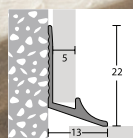
PV25/35Dim.: **2,50m**Ref.: **RLVT1352411**

Terminal Degrau
Skirting section
Perfilé nez-de-marche

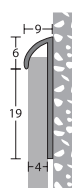
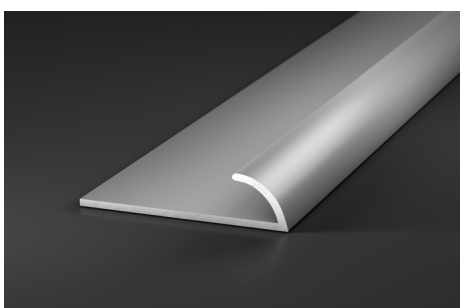
PV20/28Dim.: **2,50m**Ref.: **RLVT3811011**

Terminal Degrau
Edge trim
Perfilé à bord

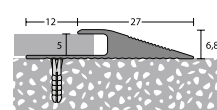
PV20/28Dim.: **2,70m**Ref.: **RLVT1412011**

Terminal de rampa
Ramp profile
Perfilé à bord

PV37.5/52.5Dim.: **2,50m**Ref.: **RLVT2691311**



Termino Esquerdo
Skirting end / Plinthe

Ref.: RLVT3720411

PV15/21



5 606779 189578



Canto interno rodapé
Skirting corner / Plinthe

PV25/35

Dim.: 6cm

Ref.: RLVT3720111



5 606779 189547



Rodapé
Skirting / Plinthe

PV30/42

Dim.: 2,70m - 6cm altura

Ref.: RLVT3722011



5 606779 182111



União
Skirting union / Plinthe

Ref.: RLVT3720311

PV15/21



5 606779 189561



Canto externo rodapé
Skirting corner / Plinthe

PV25/35

Dim.: 6cm

Ref.: RLVT3720211



5 606779 189554



Termino Esquerdo
Skirting end / Plinthe

Ref.: RLVT3720511

PV15/21



5 606779 189585



Rodapé LED
Skirting LED / Plinthe LED

PV100/140

Dim.: 2,50m - 8cm de altura

Ref.: RLVT358101140



5 606779 203823

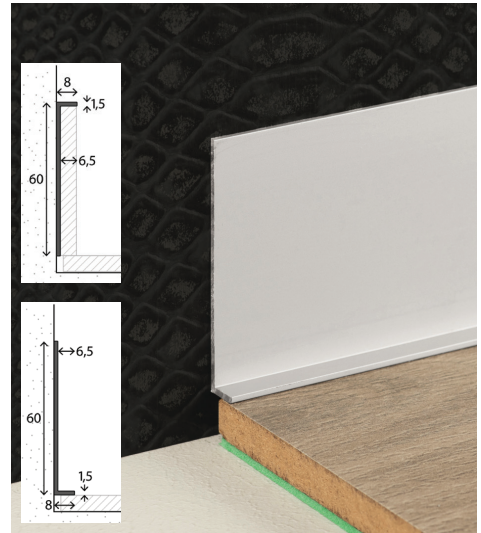

Rodapé
Skirting / Plinthe

PV30/42

Dim.: 2,50m - 6cm altura

Ref.: RLVT376101125



5 606779 203809



Rodapé + Clip RLVT8145500
Skirting + Clip
Plinthe + Clip

PV45/63

Dim.: 2,50m - 6cm altura

Ref.: RLVT3621011



5 606779 182081



Rodapé
Skirting
Plinthe

PV45/63

Dim.: 2,50m - 6cm altura

Ref.: RLVT359101140



5 606779 203816

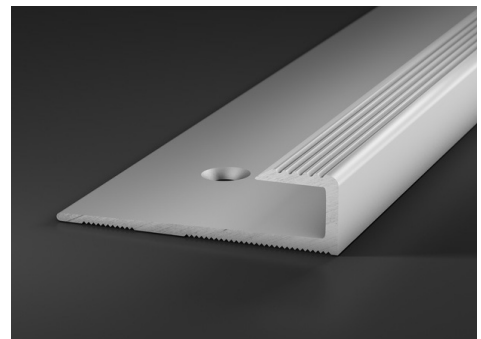

Terminal de rebordo
Edge trim
Profilé à bord

PV25/35

Dim.: 2,50m

Ref.: RLVT1431311



5 606779 182135





IDEAL PARA PROTECÇÃO DE PISOS
EM OBRAS EM CURSO

RubiProtect

Protecção de pisos
Espuma EPE com película em PP Impermeável



PRODUTO: RUBIPROTECT - **PV1.5/2.1** - m²
FORMATO: 1 x 10 m - 10m² / 3Kg
ESPESSURA: 1.5mm
REF: RTPROFLOOR



5 606779 199805

Eco-Parquet

Espuma PE com película LD e aba 10cm

PRODUTO: **ECOPARQUET - FL1.1/1.54** - m²
TIPOLOGIA: TELA DE ISOLAMENTO FLUTUANTES
FORMATO: 1,20 x 31,25 m - 37,50m² / 3Kg
ESPESSURA: 2mm
REF: RTECOPARQUET2MM



5 606779 206626



ISOLAMENTO ACÚSTICO
ISOLAMENTO CONTRA HUMIDADE
NÍVELADOR PARA PISOS COM
IRREGULARIDADES LIGEIRAS

ENSAIOS	NORMA / STANDARD	RESULTADOS RESULTS
Densidade Nominal / Nominal Density	ISO845	20 Kg/m ³
Espessura Nominal / Nominal Thickness		2 mm
Resistência à Compressão / Compressive Strength		-
25% Deformação / 25% Deformation	DIN53577	0,59 Ton/m ²
50% Deformação / 50% Deformation		4,60 Ton/m ²
Conductividade Térmica / Thermal Conductivity	ISO8301	0,05 W/mK
Resistência Térmica / Thermal Resistance	ISO8301	0,04 m ² K/W
Resistência Vapor de água / Water Vapor Resistance	SSO212582	6,5 x 10 ⁵ S/m 16 SD (m)
Ruído De Impacto / Impact Noise	EN ISO140-8 / EN ISO717-2	17/19 DB

Imperfex

Impermeabilizante
Borracha reciclada

PRODUTO: **FLEX - PV6/8.4** - m²
TIPOLOGIA: TELA PARA IMPERMEABILIZAÇÃO
FORMATO: 1 x 10 m - 10m² / 15Kg
ESPESSURA: 1.5mm
REF: RLVTVINILICFLEX



5 606779 199683



COZINHAS E BANHOS

Desenvolvido e fabricado especificamente para a conservação e cuidado de pavimentos vinílicos. É uma tela impermeável, antibacteriana, anti bolor com um excelente isolamento acústico. É a solução ideal especialmente para casas de banho e cozinhas.

ENSAIOS	NORMA / STANDARD	RESULTADOS RESULTS
Densidade / Density	EN 1849-1	1.100 kg/m ³
Classificação de fogo / Classification of fire	EN ISO 13501	A2FL-s2
Resistência ao fogo / Fire resistance	DIN 4102	Cfl-s12
Velocidade de combustão / Burning speed	ISO 3795	1,5 mm A2
Resistência à compressão / Compression Resistance	ISO 3386/1	> 22 KPa
Isolamento ao ruído de impacto / Isolation of impact noise	ISO 140/B	30 dB
Ruído de reberberação / Reverb noise	ISO 140/B	35 %dBA
Coeficiente de permeabilidade / Permeability coefficient	ISO 12572	0.001 mg/h
Difusão de vapor de água / Diffusion of water vapor	EN 12086	> 1700
Resistência Térmica / Thermal Resistance	EN 12667	0.067 w/m.k

Aluflex

Isolamento Térmico e Acústico
EVA com superfície em alumínio

PRODUTO: **FLEX - PV5.4/7.56** - m²
TIPOLOGIA: **TELAS PARA ISOLAMENTO**
FORMATO: **1,20 x 25 m - 30m² / 8Kg**
ESPESSURA: **2mm**
REF: **RLVTALUFLEX**



5 606779 184542



IDEAL PARA PISO RADIANTE

* Lado prateado para cima
Silver side up
Coté argent vers le haut

Especialmente concebido para sistemas de aquecimento de pisos, devido ao seu duplo papel: por um lado o alumínio ajuda a regular a fonte de calor, pelo outro cria uma barreira de vapor que evita que a humidade afecte o solo.

Reduz cargas eletroestáticas e aumenta a condutividade elétrica, atuando como difusor de calor e dissipando a eletricidade estática.

ENSAIOS	NORMA / STANDARD	RESULTADOS RESULTS
Densidade / Density	EN 1849-1	250 Kg/³
Coefficiente de permeabilidade / Permeability coefficient	ISO 12572	0,001 mg/h
Resistência à compressão / Compression Resistance	ISO 3386/1	150 Kpa
Resistência Térmica / Thermal Resistance	UNE-EN 12667	0,300 m ² .K/W
Condutividade térmica / Thermal conductivity	ISO 8301	0,036 w/m.K
Reflexão / Reflection	REFLETIVIDADE	97%
Isolamento ao ruído de impacto / Isolation of impact noise	ISO 140/8	26 dB
Isolamento ao ruído aéreo / Airborne insulation	ISO 140/8	15 dB
Espessura e conformidade / Thickness and compliance	-	2 mm ± 10%
Classificação de fogo / Classification of fire	EN ISO 13501	B
Resistência ao fogo / Fire resistance	DIN 4102	BFL-s1
Velocidade de combustão / Burning speed 2mm < 100mm	ISO 3795	> 10
Fator de difusão de vapor de água / Water vapor diffusion fator	EN 12086	> 1700

Flex

Isolamento Térmico e Acústico
EVA com filme na superfície

PRODUTO: **FLEX - PV3.9/5.46** - m²
TIPOLOGIA: **TELAS PARA ISOLAMENTO**
FORMATO: **1,20 x 25 m - 30 m² / 8Kg**
ESPESSURA: **1.5mm**
REF: **RLVTFLEX**



5 606779 184559



* Lado vermelho para cima
Red side up
Coté rouge vers le haut

ENSAIOS	NORMA / STANDARD	RESULTADOS RESULTS
Densidade / Density	EN 1849-1	250 Kg/³
Coefficiente de permeabilidade / Permeability coefficient	ISO 12572	0,001 mg/h
Resistência à compressão / Resistance to compression	ISO 3386/1	150 Kpa
Isolamento ao ruído de impacto / Isolation of impact noise	ISO 140/8	26 dB
Isolamento ao ruído aéreo / Air noise isolation	ISO 140/8	15 dB
Espessura e conformidade / Thickness and compliance	-	2 mm ± 10%
Classificação de fogo / Classification of fire	EN ISO 13501	B
Resistência ao fogo / Fire resistance	DIN 4102	BFL-s1
Velocidade de combustão / Burning speed 2mm < 100mm	ISO 3795	> 10
Fator de difusão de vapor de água / Water vapor diffusion fator	EN 12086	> 1700
Condutividade térmica / Thermal conductivity	EN 12667	0,038 w/m.k
Resistência térmica / Thermal resistance	EN 12667	0,044 m ² .k/w



PARÂMETROS TÉCNICOS
technical features | paramètres techniques
technische daten | parámetros técnicos

Informações adicionais sobre SPC



Rubifloor SPC é uma evolução na família de pisos vinílicos. Com tecnologias avançadas de impressão e texturização, obtemos placas para piso mais atraentes e com o melhor desempenho do mercado.

Rubifloor SPC, significa Stone Plastic Composite, ou seja o seu componente principal é carbonato de cálcio (cerca de 60%) combinado com pó de PVC e estabilizador (cerca de 40%).

Diferente de piso de vinil regular (LVT), não tem plasticizantes, por isso é mais ecológico.

É muito mais estável dimensionalmente, impermeável e resistente ao fogo.

Os pisos SPC podem ser instalados em qualquer ambiente com exposição à humidade e flutuações de temperatura. Mas quando se trata de mudanças extremas de temperatura, o piso de SPC oferece um desempenho muito superior comparado com LVT ou WPC, bem como, o núcleo mais denso dos pisos SPC torna-os ainda mais resistentes à expansão e contração.

Rubifloor SPC is an evolution in the family of vinyl flooring. With advanced printing and texturizing technologies, we get the most attractive and best-selling vinyl floor tiles on the market. Rubifloor SPC stands for Stone Plastic Composite, ie its main component is the sum of lime stone (calcium carbonate), PVC powder and stabilizer.

It is much more stable, waterproof and fire resistant.

Rubifloor SPC est une évolution dans la famille des revêtements de sol en vinyle. Grâce aux technologies avancées d'impression et de texturation, nous obtenons les carreaux de sol en vinyle les plus attrayants et les plus vendus sur le marché. Rubifloor SPC signifie Stone Plastic Composite, c'est-à-dire que son composant principal est la somme de la pierre à chaux (carbonate de calcium), de la poudre de PVC et du stabilisant.

Il est beaucoup plus stable, imperméable et résistant au feu.

Rubifloor SPC es una evolución en la familia de pisos de vinilo. Con tecnologías avanzadas de impresión y texturización, obtenemos placas para suelo vinílico más atractivo y con mejor desempeño en el mercado. Rubifloor SPC, significa Stone Plastic Composite, es decir: su componente principal es la suma de la piedra de cal (carbonato de calcio), polvo de PVC y estabilizador.

Es mucho más estable, impermeable y resistente al fuego.

Rubifloor SPC ist eine Evolution in der Familie der Vinylböden. Mit fortschrittlichen Druck- und Texturtechnologien erhalten wir die attraktivsten und meistverkauften Vinyl-Bodenfliesen auf dem Markt. Rubifloor SPC steht für Stone Plastic Composite, dh seine Hauptkomponente ist die Summe aus Kalkstein (Calciumcarbonat), PVC-Pulver und Stabilisator.

Es ist viel stabiler, wasserfest und feuerbeständig.

VANTAGENS

- 2 vezes mais forte que o vinil convencional
- Extra rígido, sem plasticizantes
- Alta resistência a temperaturas
- Alta estabilidade dimensional (sem deformações ou aberturas no encaixe quando exposto a altas temperaturas)
- Não é necessária aclimatização das peças
- Possibilidade de instalação de até 100m² sem juntas de dilatação
- Alta Resistência a impactos
- Pode ser usado em casas de banho, lavandarias e cozinhas

CARACTERÍSTICAS

O chão reage a mudanças de temperatura. Após contínuos ciclos de retração/expansão, é comum ver aberturas entre as placas de LVT após 2 ou 3 anos devido à pressão aplicada por essas variações de temperatura no sistema de travamento.

Graças à força extremamente alta do sistema de travamento do SPC, não haverá espaços entre placas mesmo após vários anos de uso.

BENEFITS

- 2 times stronger than conventional vinyl
- Extra hard, without plasticizers
- High resistance to temperatures
- High dimensional stability (no deformations or openings in the insert when exposed to high temperatures)
- No acclimatization of parts
- Possibility of installation of up to 100m² without expansion joints
- High impact resistance
- Can be used in bathrooms, laundries and kitchens

CHARACTERISTICS

While normal LVT is too flexible to pre-attach a backing, Rubifloor SPC comes with EVA pad pre-attached.

Less installation costs - No underlay or expensive leveling compound required!

The floor is expanding/shrinking with temperature change. After repeating shrinking/expansion cycles, the pressure applied by those variations on the locking system is very high. It is common to see opening between planks after 2 or 3 years because the locking strength is too weak to stand the pressure. Thanks to extremely high locking system strength, there will be not be gaps between SPC planks, even after several years of use.

AVANTAGES

- 2 fois plus fort que le vinyle conventionnel
- Extra dur, sans plastifiants
- Haute résistance aux températures
- Stabilité dimensionnelle élevée (pas de déformations ou d'ouvertures dans l'insert exposé à des températures élevées)
- Pas d'acclimatation des pièces
- Possibilité d'installation jusqu'à 100m² sans joints de dilatation
- Résistance élevée aux chocs
- Peut être utilisé dans les salles de bains, les blanchisseries et les cuisines

CARACTÉRISTIQUES

Alors que le LVT normal est très flexible pour pré-attacher un support, le noyau dur du SPC est livré avec une couche EVA pré-couplée.

Moins de coûts d'installation - Aucune couverture ou composé de remplissage requis!

Le sol réagit au changement de température. Après des cycles répétés de rétraction / expansion, la pression appliquée par ces variations dans le système de verrouillage est très élevée. Il est courant de voir l'écart entre les plaques après 2 ou 3 ans parce que la force de verrouillage est trop faible pour résister à la pression. Grâce à la force extrêmement élevée du système de verrouillage avec le SPC, il n'y aura plus d'espace entre les plaques d'utilisation.

Rubifloor SPC

Proteção UV
UV Protection
UV-Schutz
Protección UV

Camada de desgaste
Wear layer - Couche d'usure
Nutzschicht
Capa de desgaste

Película decorativa
Decorative film - Film décoratif
Dekorfolie - Película decorativa

Base Compósito de Pedra
Stone composite
Composite de Pierre
Compuesto de piedra

Tela IPES
IPES Underlay
Sous-couche IPES
Manta IPES

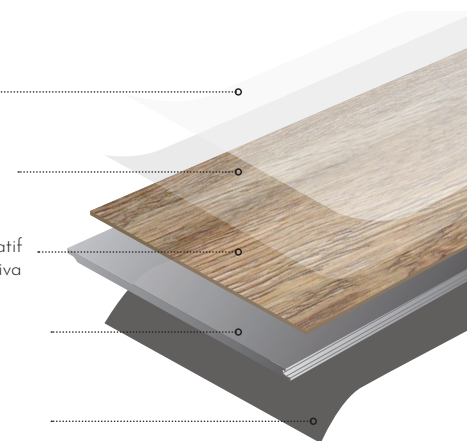

VENTAJAS

- 2 veces más fuerte que el vinilo convencional
- Extra rígido, sin plastificantes
- Alta resistencia a las temperaturas
- Alta estabilidad dimensional (sin deformaciones o aberturas en el encaje cuando expuesto a altas temperaturas)
- No es necesaria aclimatación de las piezas
- Posibilidad de instalación de hasta 100m² sin juntas de dilatación
- Alta resistencia a impactos
- Puede ser utilizado en cuartos de baño, lavanderías y cocinas

CARACTERÍSTICAS

Mientras que el LVT normal es muy flexible para pre-adjuntar un soporte, el núcleo rígido del SPC viene con una capa EVA pre-acoplada.

Menos costos de instalación - ¡No es necesario un manto o un compuesto de relleno!

El suelo reacciona al cambio de temperatura. Después de repetir ciclos de retraction / expansión, la presión aplicada por estas variaciones en el sistema de bloqueo es muy alta. Es común ver la apertura entre las placas después de 2 o 3 años, porque la fuerza de bloqueo es muy débil para soportar la presión. Gracias a la fuerza extremadamente alta del sistema de bloqueo, con el SPC, no habrá espacios entre tablas incluso después de varios años de uso.

Especificações Técnicas

Technical Specifications / Spécifications techniques / Especificaciones técnicas / Technische Daten

	Resistente à água. Water resistant Résistant à l'eau Wasserbeständig Resistente al agua		Com resistência elástica With elastic resistance Avec résistance élastique Mit elastischen Widerstand Con resiliencia elástica		Montagem de encaixe Clic mounting Assemble de click Anpass-System Montaje enchufable
	Áreas domésticas com uso intensivo Domestic areas with intensive use Utilisation domestique intensif Áreas domésticas con uso intensivo Wohngebiete mit intensiver Nutzung		Uso comercial moderado Moderate commercial use Utilisation commerciale modérée Uso comercial moderado Mäßige kommerzielle Nutzung		Uso industrial generalizado Generalized industrial use Utilisation industrielle généralisée Uso industrial generalizado Generalisierte industrielle Nutzung
	Resistente ao impacto Impact resistant Résistant aux chocs Stoßfest Resistente al impacto		Antideslizante Anti slip Antidérapant Rutschfest Antideslizante		Matéria reciclada Recycled matter Matière recyclée Materia reciclada Recyclingmaterial
	Resistente á abrasão Abrasion resistant Résistant à l'abrasion Abriebfest Resistente a la abrasión		Libre de formaldeído Formaldehyde-free Sans formaldéhyde Formaldehydfrei Libre de Formaldeído		EIR Superfície com texturas EIR Textured surface EIR Surface avec textures EIR Oberflächenstruktur EIR Texturas en la superficie
	Resistente a produtos químicos domésticos Resistant to household chemicals Résistant aux produits chimiques ménagers Beständig gegen Haushaltschemikalien Resistente a los productos químicos domésticos		Isolamento acústico superior Higher acoustic insulation Isolation acoustique supérieur Höhere Schalldämmung Aislamiento acústico superior		Tela incorporada Incorporated underlayment Sous-couche intégrée Contrapiso incorporado Eingebaute Unterzählung
	Compatível com piso radiante Compatible with underfloor heating Compatible avec le chauffage par le sol Compatible con calefacción por suelo radiante Kompatibel mit Fußbodenheizung		Resistente ao fogo Fire resistant Résistant au feu Resistente al fuego Feuerresistent		Antibacteriano Anti-bacterial Antibactérien Antibacteriano Antibakteriell

Classificação • Classification • Klassifizierung • Clasificación	Norma • Standard Norme • Norm	Resultado Result • Résultat
Norma Europeia - European Standard - Norme Européenne - Europäische Norm - Norma Europea	EN685	33/42 - 0,5mm 21/31 - 0,3mm
Inflamabilidade - Inflammability - Inflammabilité - Entzündbarkeit - Inflamabilidad	BS EN 13501	Bfl-S1
Determinação do comportamento ao fogo de produtos de pavimentação utilizando uma fonte de calor radiante; Determination of the burning behaviour using a radiant heat source; Détermination du comportement au feu à l'aide d'une source de chaleur rayonnante; Ermittlung des Verhaltens der Bodenbeläge auf Brand mit einer Hitze-Strahlungsquelle Determinación del comportamiento a la quema de los productos utilizando una fuente de calor radiante de pavimentación	EN ISO 9239-1	Bfl-S1
Isolamento acústico - Acoustic insulation - Isolation phonique - Schalldämmung - Aislamiento de sonido	EN ISO 717-2	5dB
Performance • Aufführung	Norma • Standard Norme • Norm	Resultado Result • Résultat
Resistência ao desgaste - Wear resistance - Résistance à l'usure Verschleißbeständigkeit - Resistencia al desgaste	EN660-1	Group T
Marcas residuais após recuo de carga estática Residual indentation mark after static load - Marques résiduelles après chargement statique Reststoffe nach Rückzug statischer Belastung Marcas residuales después de la remoción de la carga estática	EN436	Passou - Passed Passé - Bestanden
Estabilidade dimensional e enrolamento após exposição ao calor Dimensional stability and curling after exposure to heat Stabilité dimensionnelle et incurvation à la chaleur Formbeständigkeit und Krümmung nach Einwirkung von Wärme estabilidad dimensional después de la exposición al calor	EN434	Passou - Passed Passé - Bestanden
Flexibilidade - Flexibility - Flexibilité - Flexibilität - Flexibilidad	EN435	Passou - Passed Passé - Bestanden
Medição do coeficiente de atrito dinâmico em pavimentos secos Measurement of dynamic coefficient of friction on dry floor surfaces Mesure du coefficient dynamique de friction sur des surfaces de sol sèches Messung des dynamischen Reibungskoeffizienten auf trockenem Bodenbelag Medición de coeficiente de fricción dinámico en seco pisos	EN434	Passou - Passed Passé - Bestanden
Resistência anti deslizamento - Anti-slip Resistance - Résistance au glissement Gleitwiderstand - Resistencia a deslizamiento	DIN51130	R10
Resistência a Químicos - Resistance to chemicals - Resistance aux chimiques Beständigkeit gegen Chemikalien -	EN423	Class 0
Teste de fungos - Fungus Test - résistance à la formation de fungus Beständigkeit gegen Pilzbildung - Resistencia a la formación de hongos	ASTM G21	Class 0

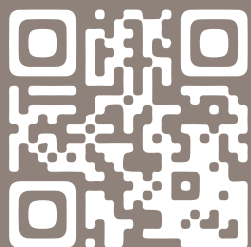

IOS

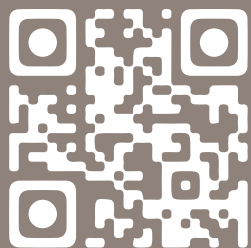

ANDROID



SEDE • SHOWROOM • WAREHOUSE - Portugal
Avenida 16 de Maio, nº 1290
3880-102 Ovar, Portugal
T.: (+351) 256 790 140
Email: geral@rubicer.pt

Showrooms:
Ovar - Portugal
Algarve - Portugal
Castellón - Espanha

SHOWROOM & WAREHOUSE - Espanha
RUBICER Europa, S.L.
Ctra. Onda-Villarreal. Km. 2
12200 ONDA (Castellón)
T.: (+34) 662 486 557
Email: ventassp@rubicer.pt

www.rubicer.pt



exceLênciA



COMPRO
O QUE É NOSSO